

# KOBE

## BASE



### FINISHES



ANTHRACITE  
POWDER COAT



### USE

Outdoor

### ORIGIN

China

### FRAME

Aluminium Powdercoated

### DESCRIPTION

The Kobe table and drybar bases are powder coated aluminum frames in a matt black finish. These bases are ideal for both indoor & outdoor applications. Counterweights are also available as an option extras and are recommended.

# KOBE

## BASE

### DIMENSIONS

#### TABLE

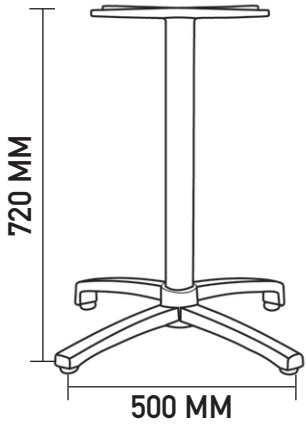

#### Spider Footprint



#### Unit KG



#### Carton



#### Top Max:

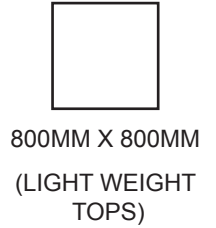

#### Base Footprint



#### BAR

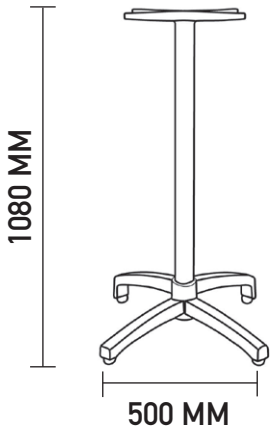

#### Spider Footprint



#### Unit KG



#### Carton

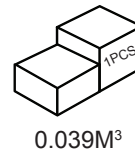

#### Top Max:

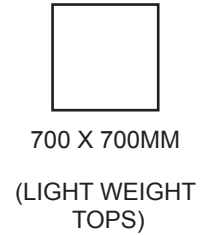

#### Base Footprint



#### TABLE 2 WAY

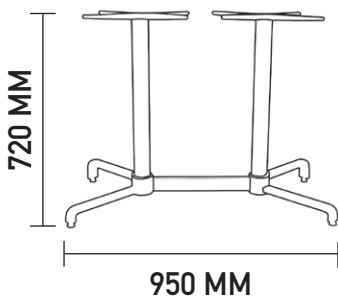

#### Spider Footprint

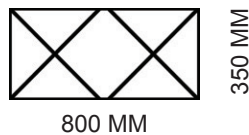

#### Unit KG



#### Carton



#### Top Max:

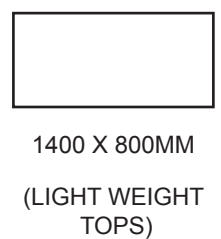

#### Base Footprint

